



## INFRASAUNA SERIES

### **Installation and Operating Instructions**

Tylö® Kiruna Hybrid™ 2

**TYLÖ**

THIS PAGE IS INTENTIONALLY BLANK



*Sauna360 congratulates you on your decision to enjoy the finest sauna available...*

*Welcome to the growing family of Tylö® sauna owners.*

Before you begin reviewing the manual, please take a moment to register your warranty. Doing so will assist us in contacting you for any important notification.

Prior to registering, you will need the serial number(s) located on the equipment.

To register, please go to <http://tylo.com/en-us/warranty>



FOR YOUR RECORDS

IS Room Model/Serial Number: \_\_\_\_\_

Sauna Heater Model/Serial Number: \_\_\_\_\_

Control Model/Serial Number: \_\_\_\_\_

Contact Box Model/Serial Number: \_\_\_\_\_

Date Purchased: \_\_\_\_\_

Dealer: \_\_\_\_\_

Address: \_\_\_\_\_

Phone Number: \_\_\_\_\_

Website/Email: \_\_\_\_\_

**If questions arise regarding this product or this manual, please contact your authorized Tylö dealership.** They are trained professionals who are familiar with the product as well as new sauna ownership concerns. Their expertise will facilitate the enjoyment of your new **Tylö** sauna.

**IMPORTANT: SAUNA360** reserves the right to change specifications or design without notification and without incurring any obligation.

THIS PAGE IS INTENTIONALLY BLANK

**Table of Contents**

SECTION 1. BEFORE YOU BEGIN ..... 1

SECTION 2. SAFETY INFORMATION ..... 2

    2.1. CONSTRUCTION and INSTALLATION SAFETY ..... 2

    2.2. USER and OPERATIONAL SAFETY ..... 3

SECTION 3. INSTALLATION REQUIREMENTS ..... 4

SECTION 4. PART LIST and TOOL REQUIREMENTS ..... 5

SECTION 5. IS ROOM ASSEMBLY ..... 6

SECTION 6. ELECTRICAL HOOK-UP ..... 14

SECTION 7. CONTROL INSTALLATION ..... 17

SECTION 8. CONTROL QUICK GUIDE ..... 18

SECTION 9. INSTALLING SAFETY PLACARDS ..... 19

SECTION 10. PLACING SAUNA ROCKS ..... 20

SECTION 11. HOW TO TAKE A SAUNA ..... 21

SECTION 12. MAINTENANCE ..... 22

SECTION 13. TROUBLESHOOTING ..... 22

    13.1. PRE-HEAT MODE ..... 22

    13.2. SENSOR NOT DETECTED ..... 23

    13.3. HIGH LIMIT ERROR ..... 23

    13.4. DOOR OPEN ..... 24

    13.5. JUMPER ERROR ..... 24

    13.6. INFORMATION ..... 24

## SECTION 1. BEFORE YOU BEGIN

This manual is for installation and operation of an Tylö® Kiruna Hybrid™ 2 sauna room mated with a Sense UB heater (1801-17-1902, 1801-22-1902), a Bliss IS control (1601-53) and a CB20-1 (1201-20-1) contactor (CB) box.



**Tylö® Kiruna Hybrid™ 2  
Sauna Room**



**Sense UB Heater**  
(1801-17-1902, 1801-22-  
1902)



**Bliss IS Control**  
(1601-53)



**Contactor (CB) Box**  
CB20-1 (1201-20-1)

**Figure 1.**

Use these instructions when assembling the Tylö® Kiruna Hybrid™ 2 sauna room. For best results and for protection of product warranty, please read, understand and follow all safety information, safety placards, and installation and operating instructions prior to starting the installation process. When completed, leave these instructions with the owner.

**If questions arise regarding this product or this manual, please contact your authorized Tylö dealership.** They are trained professionals who are familiar with the product as well as new sauna ownership concerns. Their expertise will facilitate the enjoyment of your new **Tylö** sauna.

**NOTE:** Black Thermosafe® fibers may be present as a normal byproduct of the manufacturing process and are not indicative of a defect. You might notice them on the heater, nearby floor, or inside the packaging. For easy cleanup, we recommend using a soft brush or vacuum cleaner.

## SECTION 2. SAFETY INFORMATION

### 2.1. CONSTRUCTION and INSTALLATION SAFETY



**WARNING - ELECTRIC SHOCK HAZARD:** High voltage exists within this equipment. There are no user-serviceable parts within this equipment. Have the equipment installed and serviced only by qualified and licensed personnel in accordance with local and national codes.



**WARNING - ELECTRIC SHOCK HAZARD: DO NOT** install electrical receptacles inside the sauna room.



**WARNING:** If installing a fire sprinkler system inside the sauna room, ensure it is properly rated for sauna room temperatures.



**CAUTION: DO NOT** assemble the sauna room as to restrict or obstruct the air inlet and exhaust vents.



**CAUTION:** Loose electrical connections can cause heat damage to wires, terminal blocks and other components. Improper connections may void product warranty. Ensure all electrical connections are installed and inspected by qualified and licensed personnel.



**IMPORTANT:** The door to the sauna room must open outward, to the exterior of the sauna room.



**IMPORTANT: DO NOT** install a lock or mechanical locking device onto the door of the sauna room. If needed, use only a magnetic or spring-loaded catch mechanism that allows the door to open when pressed or pulled.



**IMPORTANT:** To prevent electrical shock, provide adequate electrical grounding to the heater and CB Box.



**IMPORTANT:** Do not install a shower in the sauna room.

**NOTE:** Use only approved sauna room materials for interior construction of the sauna room. Installation of unapproved materials or accessories may void product warranty

**NOTE:** To protect product warranty, only qualified licensed personnel should perform installation and service to this equipment.

**NOTE:** A GFCI (Ground-Fault Circuit Interrupter) device is not required by NEC. Only install a GFCI if required by local codes, however, be aware this will cause nuisance electrical circuit trips during use of the product.

## 2.2. USER and OPERATIONAL SAFETY



**WARNING:** Prolonged exposure to elevated temperatures can induce hyperthermia. Hyperthermia occurs when internal body temperature reaches several degrees above normal (98.6°F). Symptoms of hyperthermia include an increase in body temperature, dizziness, lethargy, drowsiness, and fainting. Effects of hyperthermia include failure to perceive heat, failure to recognize the need to exit the room, unawareness of impending hazard, fetal damage in pregnant women, physical inability to exit the room and unconsciousness.



**WARNING: DO NOT** take a sauna if using alcohol, recreational drugs, or prescribed medication as these may greatly increase risk of hyperthermia, personal injury or death.



**WARNING - FIRE HAZARD: DO NOT** use the sauna room for drying clothes, bathing suits, towels, etc. **DO NOT** hang towels above heater or place objects onto the sauna heater. Only place rocks supplied with the heater onto the heating elements. **DO NOT** place combustible materials onto the sauna heater.



**WARNING - FIRE HAZARD: IMMEDIATELY DISCONTINUE** using the sauna if the walls or ceiling exhibit unusual discoloration and/or darken in color.



**WARNING - HOT SURFACES:** The heater is extremely hot during operation. Keep hair, head, hands, body, and appendages on the safe side of guard rails. Keep children and vulnerable individuals a safe distance away from the heater. **DO NOT TOUCH** the heater while in operation as severe burns to skin may result.



**WARNING - CORROSIVE: DO NOT** pour chlorinated pool or spa water onto the heater as corrosion will occur and void product warranty.



**WARNING: DO NOT** pour excessive water onto the heater as damage may occur and void product warranty.



**CAUTION:** The benches have been tested to ISO 7173 standard and have a maximum weight limit of 250 pounds per seating position.



**IMPORTANT:** If pregnant or a person in poor health, consult with a physician before using sauna.



**IMPORTANT: DO NOT** exercise, play or roughhouse while using the sauna. Be safe and respectful of everyone.



**IMPORTANT:** Keep children, minors, and vulnerable individuals a safe distance away from a warming or hot sauna heater. Be a responsible sauna user. When needed, provide operating instructions to those less experienced. Keep operation of the sauna safe for yourself and others to enjoy.



**IMPORTANT:** Do not spray water on infrared emitters. Use of water on infrared emitters may cause damage and will void the warranty.

**NOTE:** Inspect the sauna regularly. Check for maintenance of the heater, control, and benches. Replace wood surfaces should any show signs of deterioration.

**SECTION 3. INSTALLATION REQUIREMENTS**

To ensure safe use of the IS sauna room, verify the following criteria are met:

- Two (2) adults are required for the assembly and installation of the room.
- Ensure all electrical wiring is installed in accordance with NEC, state, and local codes.
- The IS sauna room is designed to operate on 120 Volts AC (standard household current).
- The hybrid room will require either 15 amp or 20 amp service. Install electrical wire that is rated appropriately to meet or exceed the *Maximum Current Load* from the electrical panel to the receptacle. For safety, do not use extension cords, undersized, or inappropriately rated wiring.

Heater Model	Maximum Current Load	Wire Rating (Minimum)
1801-17-1902 (1.7 Kw)	15 Amp	#2 14AWG +Gr
1801-22-1902 (2.2 Kw)	20 Amp	#2 12AWG +Gr

- The power cord extends ~5 from the lower right corner of the back wall.
- A 120 VAC dedicated circuit is recommended to avoid unnecessary tripping of the assigned circuit breaker.
- Ensure the circuit breaker is rated to *ONLY* meet the design limit of the *Maximum Current Load*. Do not install an oversized/over-rated circuit breaker. Do not exceed the safety rating of the *Maximum Current Load*.
- Install either a NEMA 5-15R or 5-20R amp rated electrical receptacle. **DO NOT** install a 5-20R receptacle onto a 15 amp rated circuit.

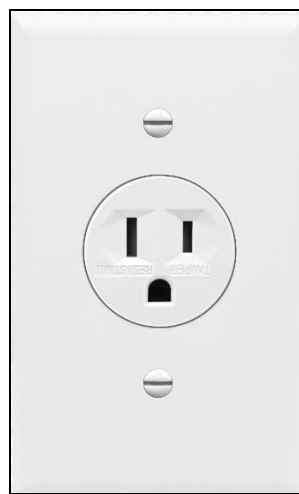

5-15R (15 Amp) Receptacle

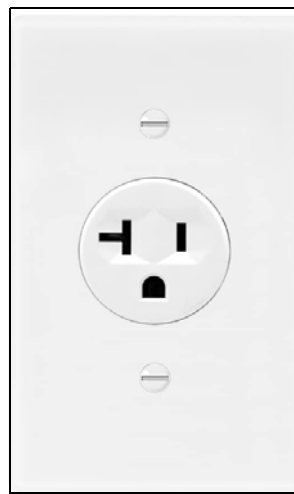

5-20R (20 Amp) Receptacle

**Figure 2.**

- Do not operate the IS sauna room should the power cord or connector become damaged or adversely discolored.
- Ventilation must comply with instructions provided in this manual.

**SECTION 4. PART LIST and TOOL REQUIREMENTS**

**PART LIST**

Inspect and verify the packaging includes the following materials.

- **Box #1:** Floor, ceiling, bench skirt, bench seats, and door handle.
- **Box #2:** Left and right walls.
- **Box #3:** Front and back walls.

Each box label indicates the model of the hybrid room and serial number. The label also provides a brief description of the box contents.

The hardware package with each room includes a T20 Torx bit.

Should it be necessary to contact your dealer or technical support, record the model and serial numbers from each box.

Box Number \_\_\_\_\_

Serial Number \_\_\_\_\_

Model Number \_\_\_\_\_

Box Number \_\_\_\_\_

Serial Number \_\_\_\_\_

Model Number \_\_\_\_\_









Box Number \_\_\_\_\_

Serial Number \_\_\_\_\_

Model Number \_\_\_\_\_

**RECOMMENDED TOOLS**

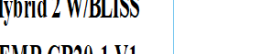
- #2 Phillips Head Screw Driver
- T20 Torx Drive
- Bubble level

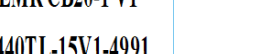
<p><b>6000-010</b></p> <p>RM Tylo Kiruna Hybrid 2 W/BLISS</p> <p>15A 120V LOW EMR CB20-1 V1</p> <p>SL# CSF30ABIS440TL-15V1-4991</p>  <p>6000-010</p>  <p>CSF30ABIS440TL-15V1-4991</p>	<p><b>6000-010</b></p> <p>RM Tylo Kiruna Hybrid 2 W/BLISS</p> <p>15A 120V LOW EMR CB20-1 V1</p> <p>SL# CSF30ABIS440TL-15V1-4991</p>  <p>6000-010</p>  <p>CSF30ABIS440TL-15V1-4991</p>
<p>Top &amp; Bottom Panel</p>  <p>6000-010</p>  <p>CSF30ABIS440TL-15V1-4991</p>	<p>Side Panels</p>  <p>6000-010</p>  <p>CSF30ABIS440TL-15V1-4991</p>
<p>BOX 1 of 3</p>  <p>CSF30ABIS440TL-15V1-4991</p>	<p>BOX 2 of 3</p>  <p>CSF30ABIS440TL-15V1-4991</p>

**6000-010**

RM Tylo Kiruna Hybrid 2 W/BLISS

15A 120V LOW EMR CB20-1 V1

SL# CSF30ABIS440TL-15V1-4991









6000-010

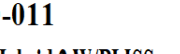

CSF30ABIS440TL-15V1-4991

Box Labels for the 15 Amp, 1.7Kw Heater

<p><b>6000-011</b></p> <p>RM Tylo Kiruna Hybrid 2 W/BLISS</p> <p>20A 120V LOW EMR CB20-1 V1</p> <p>SL# CSF30ABIS440TL-20V1-5014</p>  <p>6000-011</p>  <p>CSF30ABIS440TL-20V1-5014</p>	<p><b>6000-011</b></p> <p>RM Tylo Kiruna Hybrid 2 W/BLISS</p> <p>20A 120V LOW EMR CB20-1 V1</p> <p>SL# CSF30ABIS440TL-20V1-5014</p>  <p>6000-011</p>  <p>CSF30ABIS440TL-20V1-5014</p>
<p>Top &amp; Bottom Panel</p>  <p>6000-011</p>  <p>CSF30ABIS440TL-20V1-5014</p>	<p>Side Panels</p>  <p>6000-011</p>  <p>CSF30ABIS440TL-20V1-5014</p>
<p>BOX 1 of 3</p>  <p>CSF30ABIS440TL-20V1-5014</p>	<p>BOX 2 of 3</p>  <p>CSF30ABIS440TL-20V1-5014</p>

**6000-011**

RM Tylo Kiruna Hybrid 2 W/BLISS

20A 120V LOW EMR CB20-1 V1

SL# CSF30ABIS440TL-20V1-5014



6000-011



CSF30ABIS440TL-20V1-5014

Box Labels for the 20 Amp, 2.2Kw Heater

**SECTION 5. IS ROOM ASSEMBLY**

Use these instructions for assembling a 2-person hybrid sauna room.

**LAYING THE FLOOR PANEL**

1. Place the floor panel on a flat, level surface, between 3 and 6 inches away from nearby walls, and no more than 5 feet from the dedicated electrical receptacle.
2. Position the floor panel so label #4 is oriented towards the front of the IS room.
3. Using a bubble level, check the floor panel for level. If necessary, use wooden shims beneath the floor panel to make level.

**INSTALLING BACK WALL SECTION**

4. Place the hangers of the back wall section into the mating hangers located on the back side of the floor panel labeled #1.
5. Hold the back wall in place until left wall section is installed.



**Figure 3. Laying the Floor Panel**



**Figure 4. Installing Back Wall Section**

## INSTALLING LEFT WALL SECTION

6. Place the hangers of the left wall section into the mating hangers located on the left side of the floor panel labeled #2.
7. Lift up the left wall and slide the edge brackets into the mating brackets located on the back wall.
8. From the left side of the back wall, connect the left wall IR emitter power cable to the power input of the left wall PCA.



**Figure 5. Left Wall IR Power Connection**

9. Using the four (4) screws provided, attach the junction box cover over the left wall junction box.

## INSTALLING RIGHT WALL SECTION

10. Place the hangers of the right wall section into the mating hangers located on the right side of the floor panel labeled #3.
11. Lift up the right wall and slide the edge brackets into the mating brackets located on the back wall.
12. When the wall panels are mated correctly, verify the top edges where the corners meet are flat and flush.
13. From the right side of the back wall, connect the right wall IR emitter power cable to the power input of the right wall PCA.



**Figure 6. Right Wall IR Power Connection**

14. Using the four (4) screws provided, attach the junction box cover over the right wall junction box.



**Figure 7. Installing Left Wall Section**



**Figure 8. Installing Right Wall Section**

**INSTALLING CONTACTOR (CB) BOX**

Use Figure 9. for the following steps.

15. Remove the cover of the CB Box to gain access to the four (4) mounting holes located in the back of the box.
16. Set the hardware and cover aside in a safe location.
17. Position the CB Box onto the wooden “L” trim located inside of the Right wall.
18. Using the four (4) 3/16” x 3/4” screws supplied with the kit, attach the CB Box to the wall.
19. Use the following sub-steps if the cable track is not already pre-installed.
  - a. Remove the adhesive backing from the double-sided tape adhered on the back of the cable track.
  - b. Apply the cable track along the corner of the wall beneath the CB box.

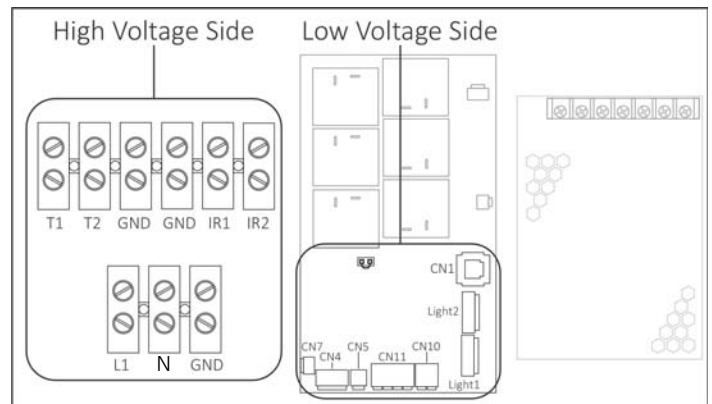

**Figure 9. Mounting the CB Box to the Wall**

**CONNECTING CABLES**

Electrical installation must be made by a licensed electrician in accordance with the National Electric Code and local regulations.

20. Route the low voltage cables through a bottom opening located on the low voltage side on the CB box.
21. Route the power cable through a bottom opening located on the high voltage side of the CB box.
22. The sauna room wires and cables are labeled according to the terminals they connect to inside the CB box. See Figure 10.
23. For additional electrical information for the CB box, see “SECTION 6. ELECTRICAL HOOK-UP” on page 14.

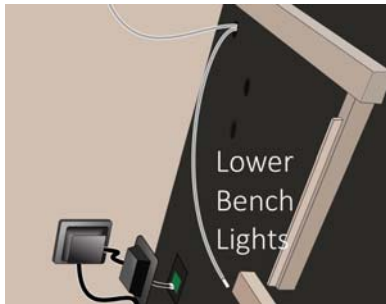

**Figure 10. CB Box Interior**

## INSTALLING LOWER BENCH SEAT

Use Figure 13. for the steps below.

24. Slide the lower bench seat over the top of the left and right lower bench braces and drop into place.
25. Connect the bench lighting cable to the corresponding cable from the right wall.



**Figure 11. Lower Bench Lights Cable**

## INSTALLING BENCH SKIRT

Use Figure 14. for the steps below.

26. Orient the bench skirt so the “tongue” on the planks are to the left, and the “groove” on the planks are to the right with the IR emitter panel facing to the front of the sauna room.
27. During installation, drape the cables over the top edge of the skirt.
28. From above the lower bench, ease the left and right edges of the bench skirt down onto the large “tongues” attached on the left and right walls.
29. From the right side of the back wall, connect the bench skirt IR emitter power cable to the power input of the bench skirt PCA.

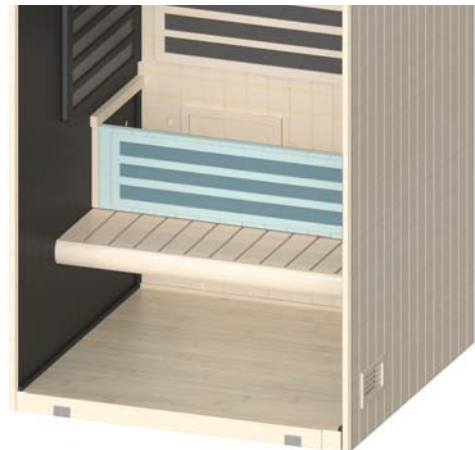

**Figure 12. Bench Skirt IR Power Cable**

30. Using the four (4) screws provided, attach the junction box cover over the bench skirt junction box.



**Figure 13. Installing Lower Bench**

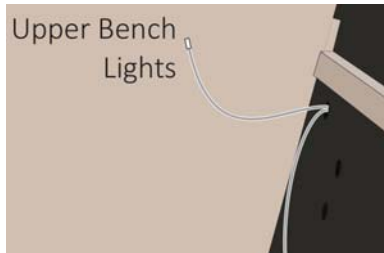

**Figure 14. Installing Bench Skirt**

### INSTALLING UPPER BENCH SEAT

Use Figure 16. for the steps below.

31. Slide the upper bench seat partially over the top of the left and right upper bench braces.
32. Connect the bench lighting cable to the corresponding cable from the wall.



**Figure 15. Upper Bench Light Cable**

33. Slide the upper bench seat all the way to the back wall and drop into place.

### INSTALLING FRONT WALL

34. Place the hangers of the front wall into the mating hangers located on the front of the floor panel.
35. Lift the front wall and slide the left and right brackets onto the edge brackets of the left and right walls. Press the front wall down into place.

All wall sections should now be attached and secure.

36. Verify the front wall is held securely in place by the left and right brackets.
37. Verify the top edge of all wall sections are level and flush.



**Figure 16. Installing Upper Bench Seat**



**Figure 17. Installing Front Wall**

## INSTALLING DOOR HANDLE

38. Arrange the door handles and hardware as shown in Figure 18. Screws and cap are installed from inside the door.
39. Place the door handles on either side of the glass door, aligning with the holes in the glass.
40. Install the spacers into the holes in the glass.
41. Using the two (2) M4 x 100mm screws included in the kit, attach the door handles to the glass door.  
**NOTE:** Install screws by hand with a screw driver  
DO NOT USE a power tool.
42. Install the caps into the ends of the handle screw holes.

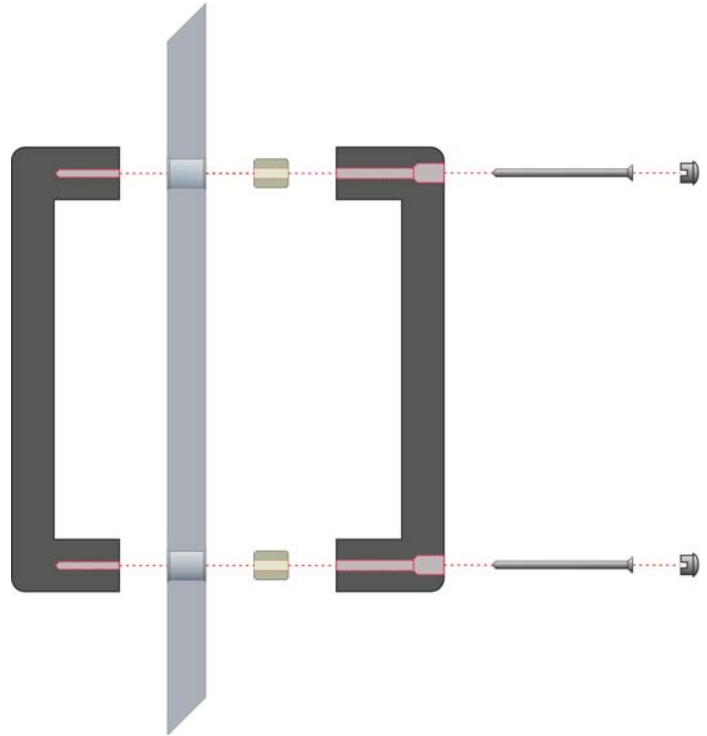

**Figure 18. Installing Door Handle**

## INSTALLING CEILING

43. From the top of the left, right, and back wall sections, Pull the ends of the cables out and over the outside edges.
44. Lift the ceiling section and gently place it between the wall sections and lock into place on the brackets.

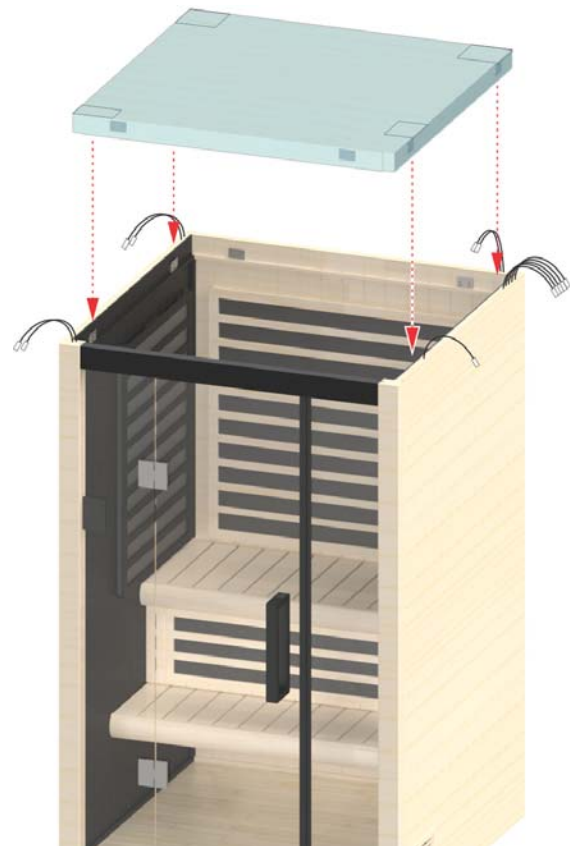
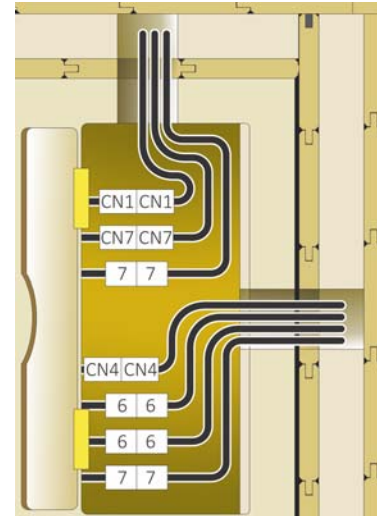

**Figure 19. Installing Ceiling**

45. From the top of the ceiling, open the four (4) hatches located on the front left, right, and back left and right.

**ELECTRICAL CONNECTIONS - Ceiling, Back Right Corner**

- 46. Fish out the seven (7) cables from the hatch.
- 47. Connect back wall CN1 cable to the CN1 ceiling cable.
- 48. Connect back wall CN7 cable to the CN7 ceiling cable.
- 49. Connect back wall 7 cable to a 7 ceiling cable.
- 50. Connect right wall CN4 cable to the CN4 ceiling cable.
- 51. Connect the two (2) right wall #6 cables to the two (2) #6 ceiling cables.
- 52. Connect right wall #7 cable to a #7 ceiling cable.
- 53. Dress the wall cables into the trenches.
- 54. Close the hatch.



**Figure 20. Ceiling, Back Right Corner**

**ELECTRICAL CONNECTIONS - Ceiling, Front Right Corner**

- 55. Fish out the one (1) cable from the hatch.
- 56. Connect right wall CN4 cable to the CN4 ceiling cable.
- 57. Dress the wall cable into the trench.
- 58. Close the hatch.

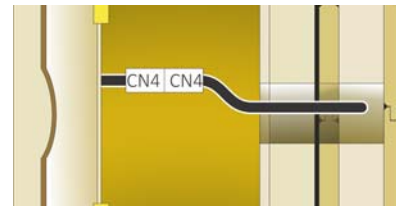

**Figure 21. Ceiling, Front Right Corner**

**ELECTRICAL CONNECTIONS - Ceiling, Front Left Corner**

- 59. Fish out the two (2) cables from the hatch.
- 60. Connect left corner CN1 cable to the CN1 ceiling cable.
- 61. Connect left corner #6 cable to the #6 ceiling cable.
- 62. Dress the corner cables into the trench.
- 63. Close the hatch.

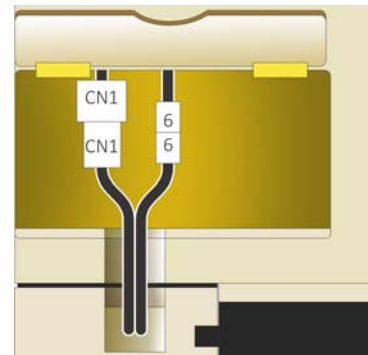

**Figure 22. Ceiling, Front Left Corner**

**ELECTRICAL CONNECTIONS - Ceiling, Back Left Corner**

- 64. Fish out the two (2) cables from the hatch.
- 65. Connect left wall #7 cable to a #7 ceiling cable.
- 66. Connect back wall #7 cable to a #7 ceiling cable.
- 67. Dress the wall cables into the trench.
- 68. Close the hatch.

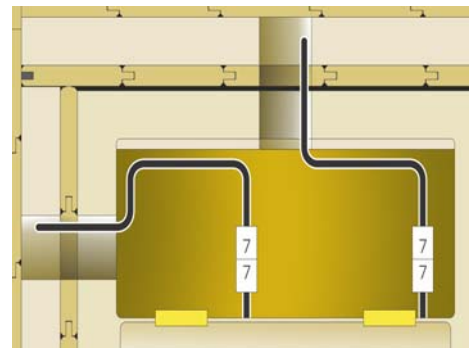
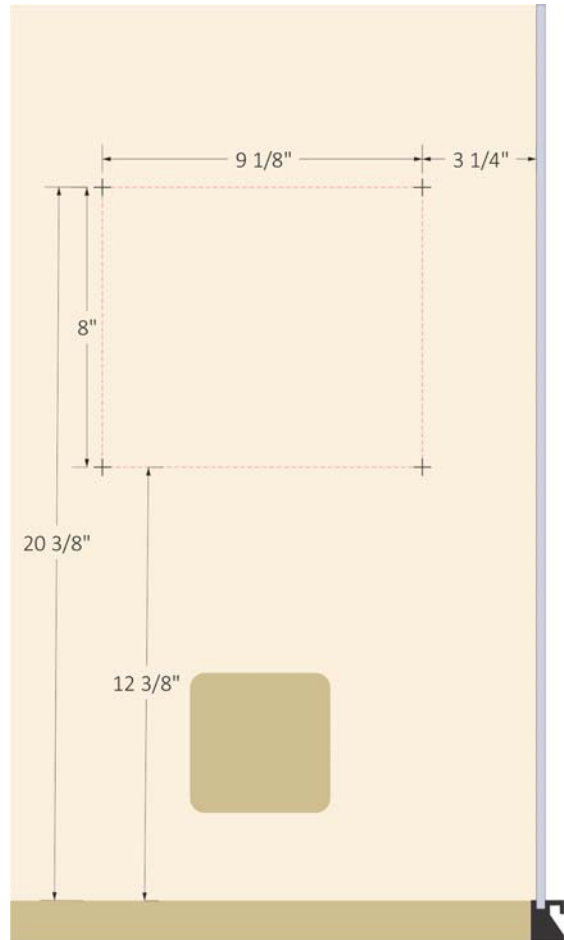

**Figure 23. Ceiling, Back Left Corner**

**MOUNTING THE HEATER**

69. Prepare the heater for installation. See the appropriate sauna heater installation and operating instruction manual.
70. Using the measurements provided in Figure 24, verify the position of the pre-drilled mounting holes for the heater.
71. Install the four (4) lag bolts (included with the heater) into the wall for mounting the heater.
72. Leave about 1/4" of the screw shaft exposed for the heater hangers to rest on.
73. Hang the heater onto the four (4) bolts, then tighten the bolts to the wall.

Instructions for electrically connecting the heater are provided later in "SECTION 6. ELECTRICAL HOOK-UP" on page 14.



**Figure 24. Mounting The Heater**

**SECTION 6. ELECTRICAL HOOK-UP**

Use Figure 25. for the following steps.

Electrical installation must be made by a licensed electrician on accordance with the National Electric Code and local regulations.

1. Route the heater power cable through an opening located on the bottom of the CB box, high voltage side.
2. Connect wires to the correct terminals. See “DIAGRAM 1. ELECTRICAL, 120VAC 1 PHASE”.

**NOTE:** The heater includes a small wire harness for the high limit control. This **MUST BE CONNECTED** for safe operation of the sauna.

3. Route the high limit control wires from the sauna heater through an available hole in the bottom of the CB Box, low voltage side.

**NOTE:** Maintain separation of high and low voltage wires.

4. Connect the wires to the high limit terminals (CN5) on the circuit board. See “DIAGRAM 1. ELECTRICAL, 120VAC 1 PHASE”.

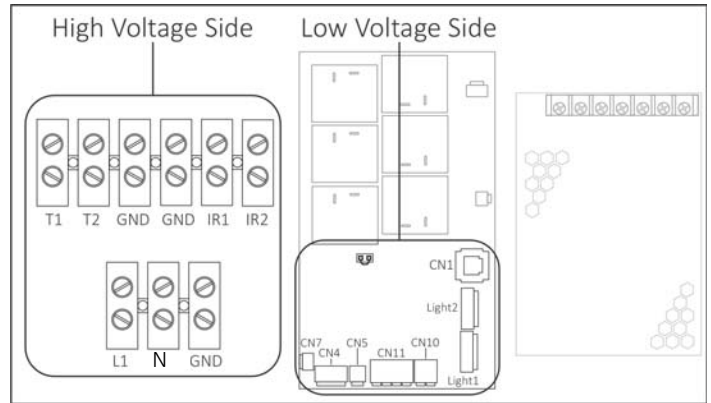

**Figure 25. CB Box Interior**

**CONNECTING POWER**

Connect the sauna room power cord into the appropriate 15 amp /5-15R or 20 amp /5-20R receptacle.

**NOTE:** Ensure the sauna room is connected to a dedicated circuit that is configured for the correct electrical rating.

**WARNING:** Incorrectly connecting the sauna room into a shared circuit will cause poor performance, circuit breaker tripping, and overheating of electrical wiring.



5-15R Receptacle



15 Amp Plug

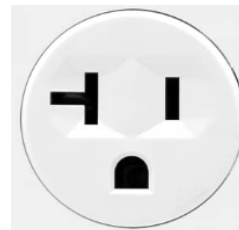

5-20R Receptacle



20 Amp Plug

**Figure 26. Connecting Power**

DIAGRAM 1. ELECTRICAL, 120VAC 1 PHASE

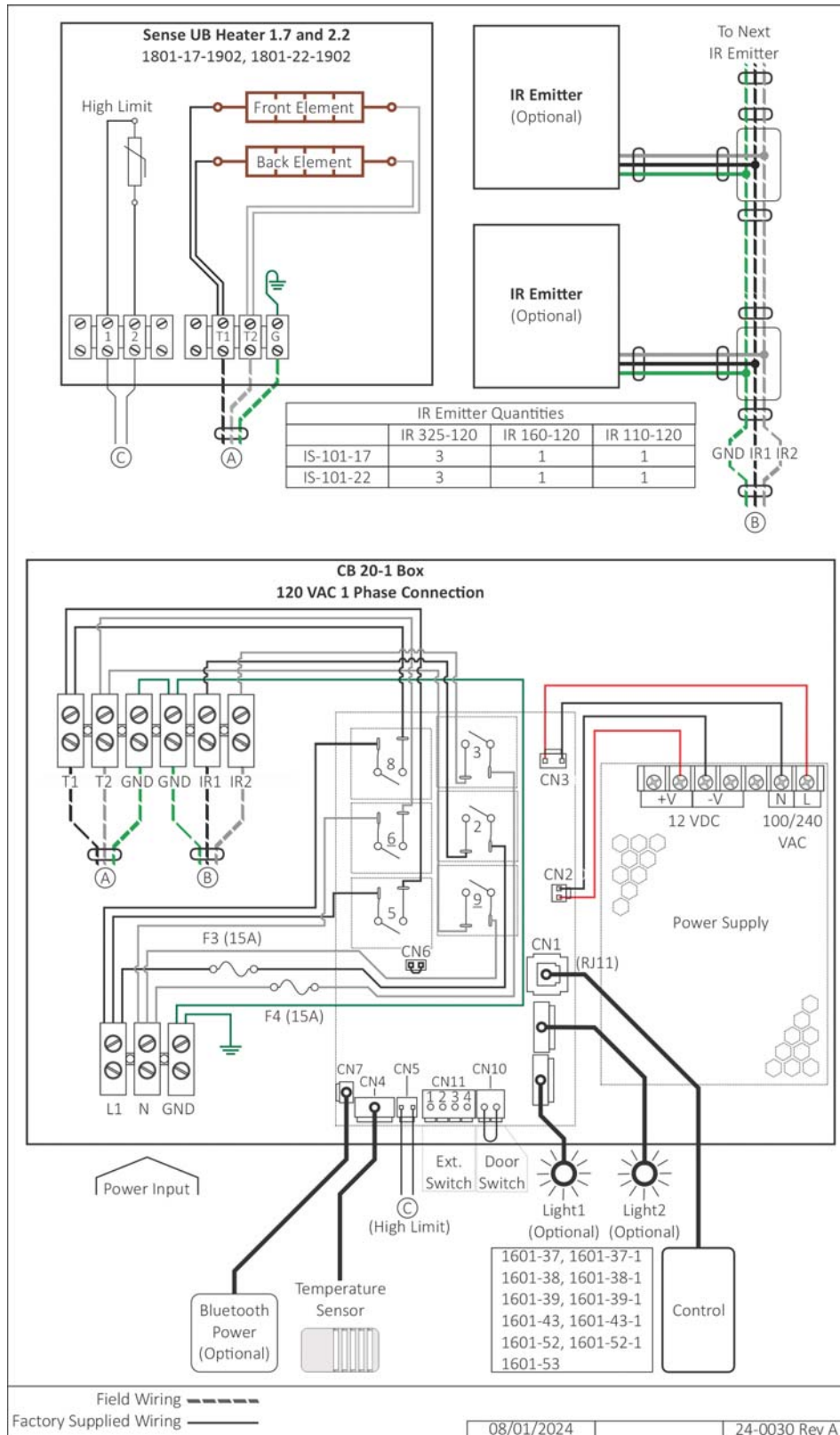
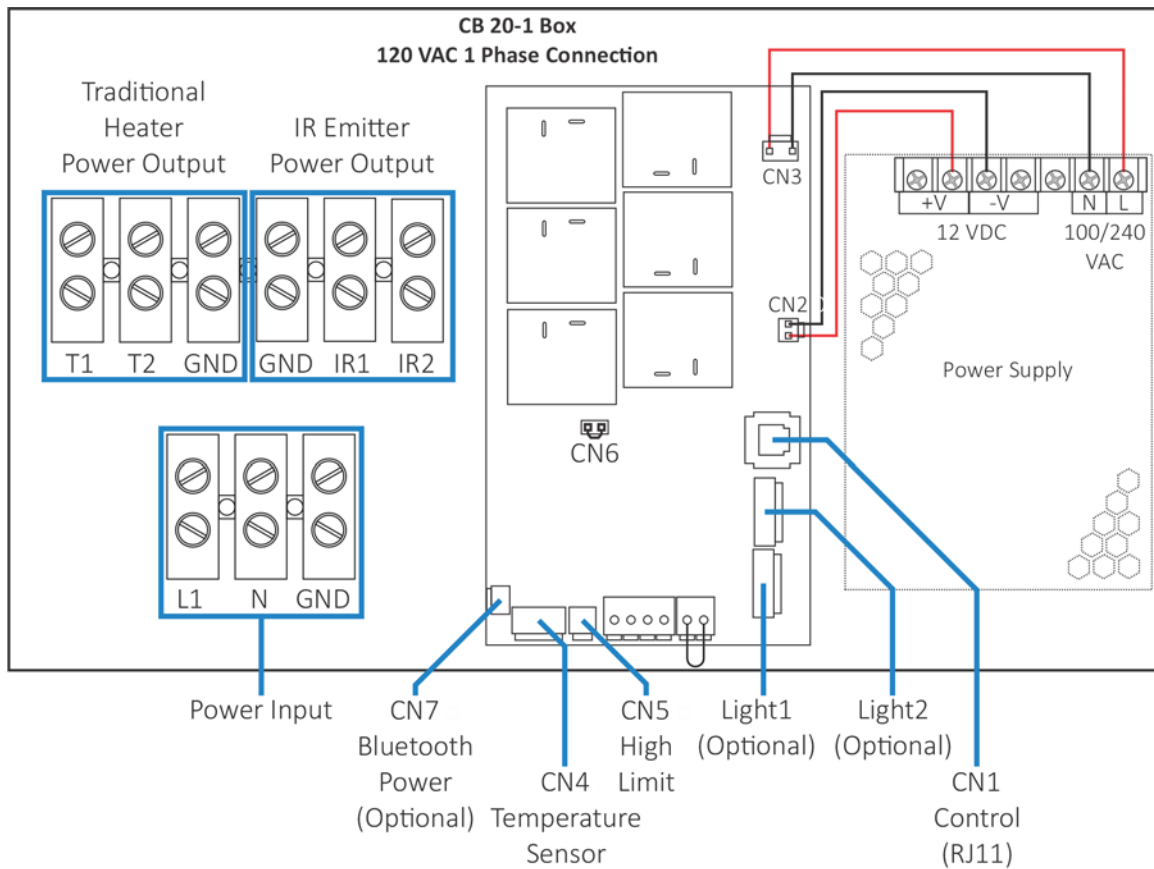

DIAGRAM 2. CB BOX INTERNAL VIEW



## SECTION 7. CONTROL INSTALLATION

The Bliss IS control is weather resistant and water resistant, allowing it to mount either on the interior or exterior of the sauna room.

If the control is not already pre-installed, use the following steps to install the control.

1. Locate the keyed circular hole in the front glass for mounting the control. The control will mount on the exterior of the glass. See Figure 27. for the remaining steps.
2. Orient the UP arrow on the back of the control (A) and insert the threaded tube through the keyed circular hole in the glass.
3. Attach the control to the glass from the interior using the threaded retaining ring (B).
4. Connect the RJ11 control cable (C) to the female RJ11 jack located inside the threaded tube of the control.
5. Neaten up the control cable, then attach the back cover (D) over the threaded retaining ring (B).

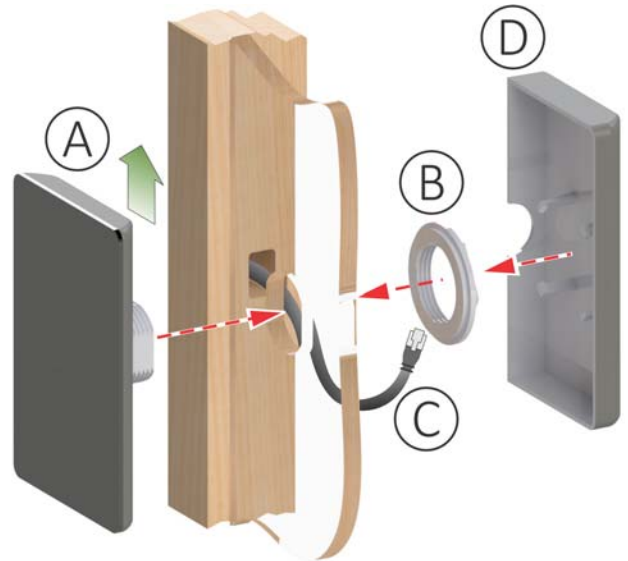

**Figure 27. Installing the Control**

SECTION 8. CONTROL QUICK GUIDE

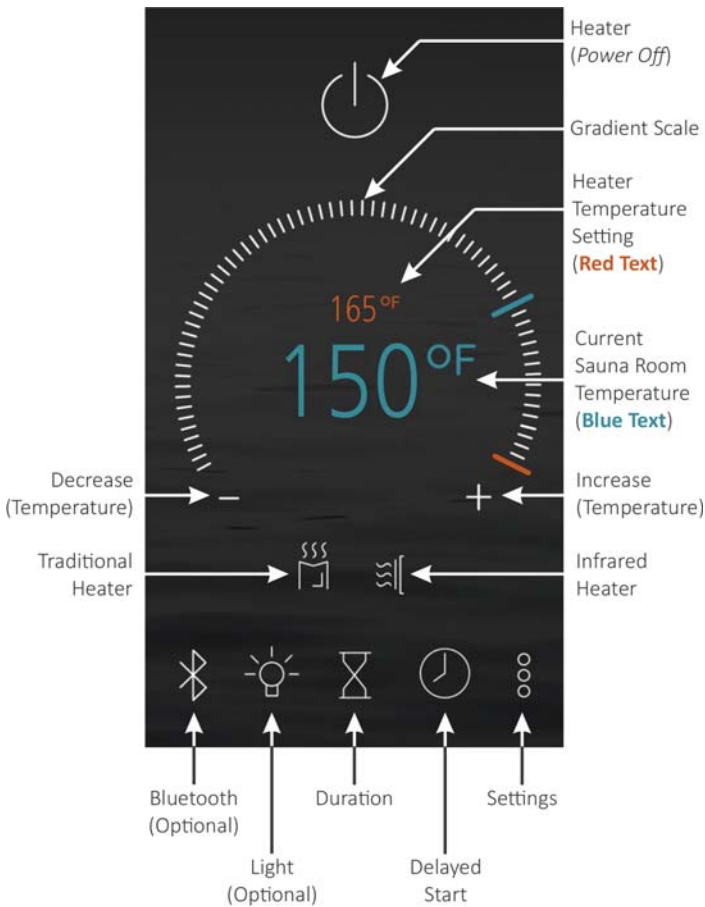

Figure 28. Control Icons

HEATER SELECTION

Tap either the **Traditional Heater** or the **Infrared Heater** icon to turn on either the traditional sauna heater or the IR emitters. For operational safety, only one or the other can be powered up at any given time.

TRADITIONAL

Tap the **Power** icon once. The default bath time is 60 minutes, and temperature settings are adjustable from 119° to 194° F for 20-amp rooms or 119° to 165° F for 15-amp rooms. **Temperature performance can vary based on factors such as the starting temperature of the room.** Length of the sauna can be set from 0 to 60 minutes. The time delay before start can be up to 24 hours. Any changes are remembered by the heater for your next bath. Should the heater power be lost then restored, the settings will return to their default values.

INFRARED

Tap the **Power** icon once. The default settings for the temperature is 149°F, the bath time is 60 minutes. These settings are adjustable from 84° to 149°. Length of the sauna can be set from 0 to 60 minutes. The time delay before start can be up to 24 hours. Any changes are remembered by the heater for your next bath. Should the heater power be lost then restored, the settings return to default values.

GRADIENT SCALE

The scale is touch sensitive. Use the tip of your finger to scroll for increasing or decreasing a selected setting (i.e. temperature, duration, light color, light intensity, Bluetooth audio volume).

HEATER TEMPERATURE SETTING

The temperature setting of the selected heater is displayed in small **red** colored text.

CURRENT SAUNA ROOM TEMPERATURE

The current sauna room temperature measured by the temperature sensor is displayed in large **blue** colored text.

INCREASE

Alternative to the gradient scale, tap the plus sign (+) icon to incrementally increase a selected setting.

DECREASE

Alternative to the gradient scale, tap the minus sign (-) icon to decrementally decrease a selected setting.

SETTINGS

Tap this icon to open the *Settings* screen.

DELAYED START

Tap this icon to open the *Delayed Start* screen.

DURATION

Tap this icon to open the *Bath Time* screen.

LIGHT (Optional)

The Bliss IS control can operate one(1) or two (2) optional lighting packages purchased with the system. Tap this icon to enable/disable the lights.

Bluetooth (Optional)

The Bliss IS control can operate **ONLY** an optional Bluetooth® package purchased with the system. Tap this icon to enable/disable audio.

## SECTION 9. INSTALLING SAFETY PLACARDS

Three (3) metal safety placards are included inside the installation instruction envelope packaged with the sauna system.



**Figure 29. Caution Placard**

1. Position the CAUTION placard in plain sight on the interior wall directly above the sauna heater and attach with the two (2) screws provided.

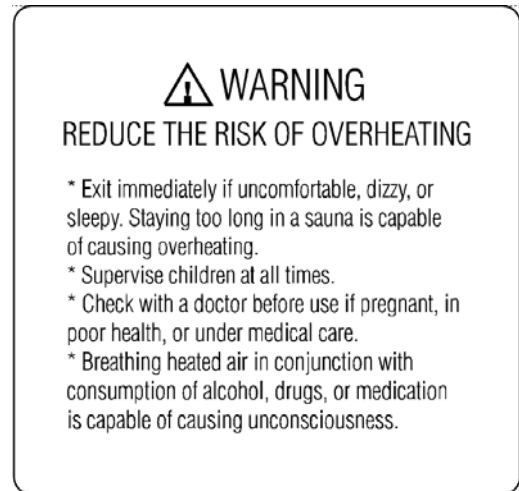

**Figure 30. Warning Placard**

2. Position the two (2) WARNING placards in plain sight on both sides of the doorway to the sauna.
3. Attach the placards using the eight (8) Screws provided, four (4) screws each.

**SECTION 10. PLACING SAUNA ROCKS**

The rocks supplied with the heater were selected with the best traditional sauna performance in mind.



**HEAVY OBJECT:** A full container of rocks is heavy. To avoid injury, bend at the knees when picking up the box.

- Use of other rock types may void heater warranty.
- **NEVER** operate heater without rocks in place!
- **RINSE** rocks with water before placing in the heater.

**CAREFULLY** place rocks loosely around the heater elements to allow efficient air circulation.

1. Remove the heater guard from the top of the heater.

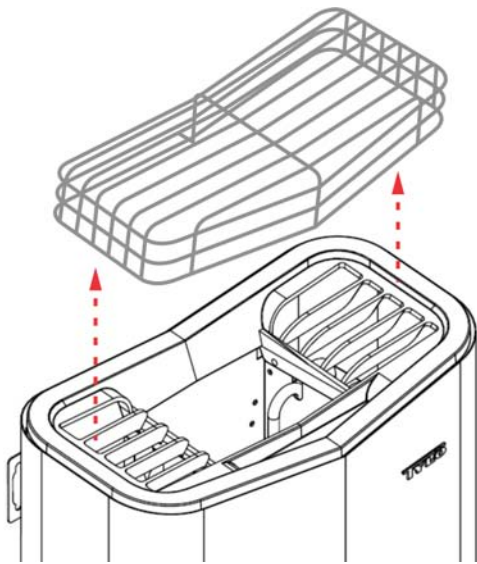

**Figure 31. Removing Heater Guard**

2. For the first layers, place smaller rocks around the outer perimeter of the heating elements.
3. Fill the middle sections with larger rocks.
4. Ensure the elements stay vertical while carefully filling the heater with rocks.
5. Place rocks loosely in the center of heater to allow heat to rise easily up the middle of heater.
6. Loosely cover the tops of all elements with rocks.

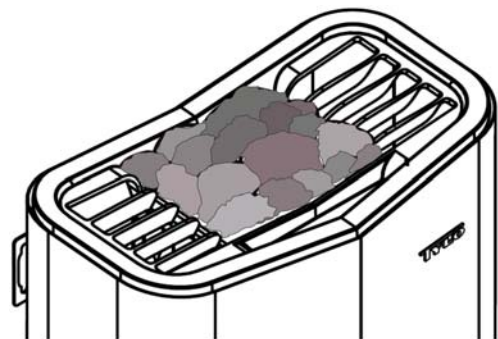

**Figure 32. Placing Rocks on Top of Elements**

7. Be careful not to pack the rocks too densely on top of the heater elements or onto the side chambers as this can impede airflow.



**Figure 33. Do Not Pack Rocks Too Densely**

8. Re-install the heater guard with the screws removed previously.

**SECTION 11. HOW TO TAKE A SAUNA**

- Devote adequate time to completely relax while taking a sauna bath.
- Before using the sauna, avoid eating a large meal and intake of alcoholic beverages. **DO NOT** smoke, exercise or drink alcoholic beverages while in the sauna room.
- If taking prescribed medications and/or under the care of a physician, consult with them prior to using the sauna.
- Remove clothing and jewelry. If preferred, wear loose-fitting clothes.
- For best results, take a warm shower before the sauna, then apply a towel loosely about the body. Enter the sauna wet without padding down to dry.
- Enjoy listening to audio books or music while relaxing in the sauna. Depending on preference, sit or lay down on the bench, adjust the vent to provide adequate air circulation.
- If desired, add colored light therapy to the experience.

**When Partaking in a Traditional Sauna:**

- Enjoy the soothing effect of steam by splashing a small amount of water onto the heated sauna rock. Use one dipper full (approximately 1/2 cup) of clean water at a time, keeping exposed skin clear of the steam as it rises off the rocks.
- **DO NOT** use chlorinated pool or spa water, as corrosion damage may result.

**When Partaking in an Infrared Sauna:**

- An IR sauna produces infrared wavelengths that are absorbed by skin tissue in a span of 10-15 minutes. It is not necessary to wait until the sauna has reached maximum temperature. The absorption rate is the same whether the room is warming up or at its maximum temperature.
- **DO NOT** splash water onto the IR emitters as this may cause damage and void product warranty.
- After ten (10) minutes or when perspiration begins, exit from the sauna, relax in the dressing area, followed by a cool shower.
- Stay hydrated, drinking water is best.
- The allotted cool down time should equal the amount of time occupying the sauna. The amount of time varies by the individual.
- Step back into the sauna room and remain for five (5) or ten (10) minutes.
- Repeat the cycle two (2) or three (3) more times.
- Enjoy a final shower or bath to cool down. Bask in the special sauna “after glow”. Partake in a healthy snack and/or a cool, refreshing drink.
- Put on clothing only after perspiration has stopped and the body is completely dry.

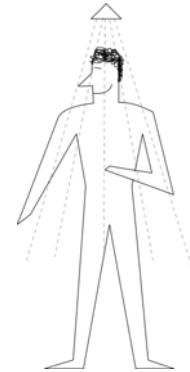

Shower



Sauna Bathe



Shower



Rest/Relax



Hydrate

## SECTION 12. MAINTENANCE

Inspect sauna room at the end of each day the room to ensure the control and system is off.

The sauna, like a bathroom, should be kept clean and odor free. Towels or mats should always be used on benches and floor as perspiration otherwise penetrates the soft wood. To clean and remove perspiration stains, use soap or detergent in warm water, best applied with a scrub brush. Badly soiled surfaces may require sanding. Sand paper wrapped around a wooden block works well.

Air out the sauna often by keeping the door and vents open when the sauna is not in use. Saunas that are in daily use should be washed down at least once a week to keep them clean and the air fresh. Duck board should be removed from the sauna, the sauna floor mopped and dried in a conventional manner, and the duck board thoroughly scrubbed and dried before returning to the sauna room. The sauna heater should be wiped down occasionally with a damp cloth to remove lint and dust. The rocks should be removed once a year for cleaning and small or crumbled rocks replaced.

Benches and supporting structure must be inspected annually for potential deterioration due to age, dry rot or abuse. Any boards with signs of deteriorations should be replaced immediately to avoid possible injury.

## SECTION 13. TROUBLESHOOTING

Should you need to contact the dealer or outlet you purchased the product, please have the model and type numbers of the heater, CB Box and control available prior to calling.

## 13.1. PRE-HEAT MODE

If the air temperature inside the sauna is below 10°F (-12°C) at startup, or if the temperature sensor is not detected, the *CAUTION Pre-Heat Mode* screen appears.



**Figure 34. CAUTION Pre-Heat Mode Screen**

1. Allow the heater to run for 5 minutes.
  - If the sensor is recognized, the CAUTION screen will go away.
  - If after 5 minutes the sensor is not recognized, the *WARNING Sensor Not Detected* screen appears. and the heater turns off.

### 13.2. SENSOR NOT DETECTED

When the sensor is not detected, power to the heater is disabled.

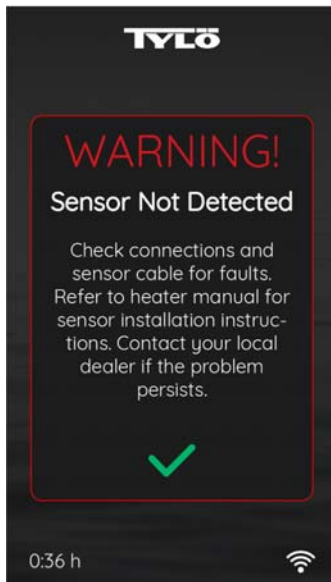

Figure 35.

1. Before performing a visual inspection, turn off circuit breakers to the sauna to remove all electrical power.
2. Refer to the content of the associated **Heater Installation and Operating Instructions** for details on the temperature sensor, cable and CB Box.
3. Check sensor electrical connections at the CB Box and at the sensor, looking for loose or broken wires, loose, corroded, or tarnished connections.
4. Inspect condition of the sensor circuit board for corrosion, tarnish and cold solder joints.
5. If the condition of the circuit board and electrical connections look good, then inspect the whole length of the sensor cable for visible damage.
6. When the inspection is completed and any user-fixable issues are corrected, re-apply power and test the operation of the sauna.
7. If the problem persists, contact your dealer.

### 13.3. HIGH LIMIT ERROR

When the high limit switch trips/activates, power to the heater is disabled.

While the heater is on and if the temperature at the heater rises above the high limit threshold, the heater shuts off, an audible control alarm is sounded, and the *WARNING High Limit Error* screen appears.

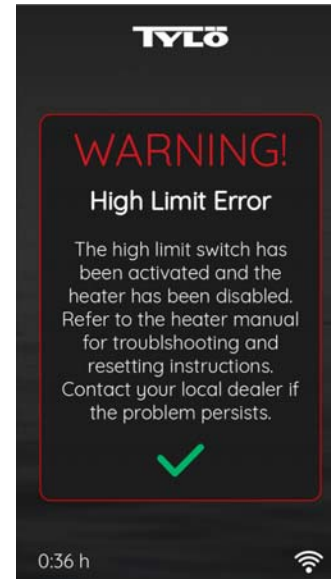
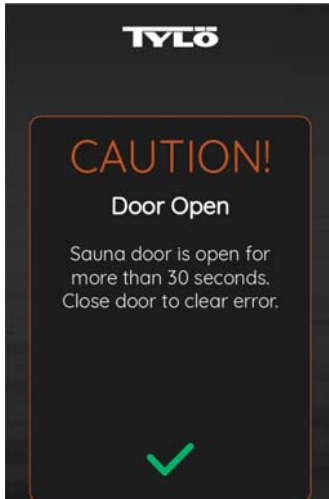

Figure 36.

1. Tap the green colored check mark.
  - The audible alarm turns off and the Home screen with heater off appears.
  - All icons on the Home screen remain functional, except for the **Power** icon.
2. Wait until temperature drops below the low temperature threshold and the high limit resets.
  - If the **Power** icon is tapped before the high limit has had time to reset, the WARNING High Limit Error screen will re-appear.
3. After the high limit has reset, tap the **Power** icon to turn the heater back on.
4. Refer to the content of the associated **Heater Installation and Operating Instructions** for details on sauna ventilation, how the heater is mounted, and placing sauna rocks to diagnose and correct the trouble. If the problem persists, contact your dealer.

**13.4. DOOR OPEN**

If an optional door switch (not provided by Sauna360) is installed, this message occurs when the control detects the sauna door is open for longer than 30 seconds.



**Figure 37. CAUTION Door Open**

Close the door within two (2) minutes and the current sauna session will continue and the error message will go away.

If the door is open for greater than two (2) minutes, the *WARNING Door Open* screen appears and power to the heater is disabled.

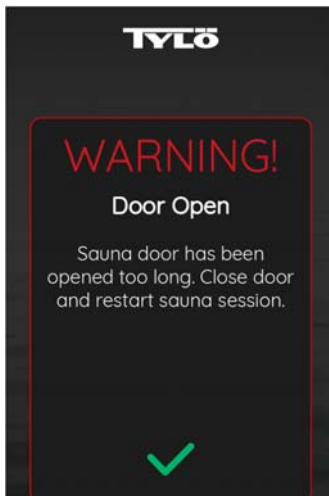

**Figure 38. WARNING Door Open**

Close the sauna door and press the green check mark, the Home Screen screen appears.

Press the **Power** icon to restart the sauna session.

**13.5. JUMPER ERROR**

This error occurs when the control detects an electrical jumper is open on the main board located in the CB Box.

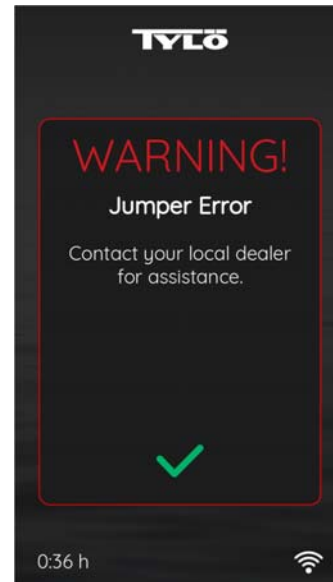

**Figure 39.**

There are no user-serviceable parts inside the CB Box. Shut off the breakers to the sauna and contact your dealer for assistance.

**13.6. INFORMATION**

When this message appears, tap the green check mark. Before inspecting, turn off the heater and allow the rocks to cool down before inspection/replacement.



**Figure 40.**

©2026 Sauna360 Inc.

The Bluetooth® word mark and logos are registered trademarks owned by Bluetooth SIG, Inc. and any use of such marks by Sauna360 is under license.

Apple® is a registered trademark of Apple Inc.

Tylö® is a registered trademark of Sauna360.

